

Plane 3 mm (T1) LED, Non Diffused

LS P380, LO P380, LY P380  
LG P380, LP P380

## Besondere Merkmale

- farbloses, klares Gehäuse
- zur Einkopplung in Lichtleiter
- als optischer Indikator einsetzbar
- Lötspieße mit Aufsetzebene
- gegurtet lieferbar
- Störimpulsfest nach DIN 40839

## Features

- colorless, clear package
- for optical coupling into light pipes
- for use as optical indicator
- solder leads with stand-off
- available taped on reel
- load dump resistant acc. to DIN 40839

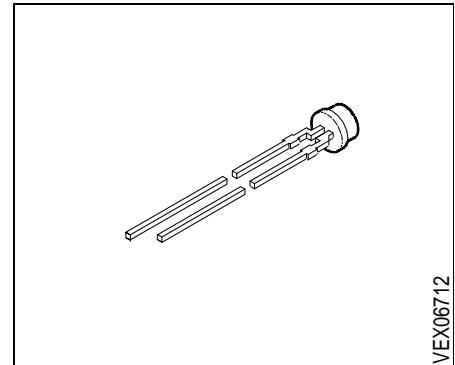

Typ Type	Emissionsfarbe Color of Emission	Gehäusefarbe Color of Package	Lichtstrom Luminous Flux $I_F = 15 \text{ mA}$ $\Phi_V (\text{mlm})$	Bestellnummer Ordering Code
LS P380-MP LS P380-N LS P380-P LS P380-NQ	super-red	red clear	16 ... 80 25 ... 50 40 ... 80 25 ... 125	Q62703-Q2466 Q62703-Q3227 Q62703-Q3228 Q62703-Q3229
LO P380-MP LO P380-N LO P380-P LO P380-NQ	orange	orange clear	16 ... 80 25 ... 50 40 ... 80 25 ... 125	Q62703-Q2465 Q62703-Q3205 Q62703-Q3206 Q62703-Q3207
LY P380-MP LY P380-N LY P380-P LY P380-NQ	yellow	yellow clear	16 ... 80 25 ... 50 40 ... 80 25 ... 125	Q62703-Q3237 Q62703-Q3238 Q62703-Q3239 Q62703-Q3240
LG P380-MP LG P380-N LG P380-P LG P380-NQ	green	green clear	16 ... 80 25 ... 50 40 ... 80 25 ... 125	Q62703-Q2463 Q62703-Q3194 Q62703-Q3195 Q62703-Q3196
LP P380-LN LP P380-M LP P380-N LP P380-MP	pure green	green clear	10 ... 50 16 ... 32 25 ... 50 16 ... 80	Q62703-Q2464 Q62703-Q2519 Q62703-Q2520 Q62703-Q3218

Streuung des Lichtstromes in einer Verpackungseinheit  $\Phi_{V \max} / \Phi_{V \min} \leq 2.0$ .  
Luminous flux ratio in one packaging unit  $\Phi_{V \max} / \Phi_{V \min} \leq 2.0$ .

**Grenzwerte**  
**Maximum Ratings**

Bezeichnung Parameter	Symbol Symbol	Werte Values		Einheit Unit
		LS, LO, LY, LG	LP	
Betriebstemperatur Operating temperature range	$T_{op}$	- 55 ... + 100	- 55 ... + 100	°C
Lagertemperatur Storage temperature range	$T_{stg}$	- 55 ... + 100	- 55 ... + 100	°C
Sperrschichttemperatur Junction temperature	$T_j$	+ 100	+ 100	°C
Durchlaßstrom Forward current	$I_F$	40	30	mA
Stoßstrom Surge current $t \leq 10 \mu s, D = 0.005$	$I_{FM}$	0.5	0.5	A
Sperrspannung Reverse voltage	$V_R$	5	5	V
Verlustleistung Power dissipation $T_A \leq 25 \text{ °C}$	$P_{tot}$	140	100	mW
Wärmewiderstand Thermal resistance Sperrschicht / Luft Junction / air	$R_{thJA}$	400	400	K/W

**Kennwerte** ( $T_A = 25\text{ °C}$ )

**Characteristics**

Bezeichnung Parameter	Symbol Symbol	Werte Values					Einheit Unit
		LS	LO	LY	LG	LP	
Wellenlänge des emittierten Lichtes (typ.) Wavelength at peak emission (typ.) $I_F = 20\text{ mA}$	$\lambda_{\text{peak}}$	635	610	586	565	557	nm
Dominantwellenlänge (typ.) Dominant wavelength (typ.) $I_F = 20\text{ mA}$	$\lambda_{\text{dom}}$	628	605	590	570	560	nm
Spektrale Bandbreite bei 50 % $\Phi_{\text{rel max}}$ (typ.) spectral bandwidth at 50 % $\Phi_{\text{rel max}}$ (typ.) $I_F = 20\text{ mA}$	$\Delta\lambda$	45	40	45	25	22	nm
Durchlaßspannung (typ.) Forward voltage (max.) $I_F = 15\text{ mA}$	$V_F$	2.1	2.1	2.1	2.1	2.1	V
Sperrstrom (typ.) Reverse current (max.) $V_R = 5\text{ V}$	$I_R$	0.01	0.01	0.01	0.01	0.01	$\mu\text{A}$
Kapazität (typ.) Capacitance $V_R = 0\text{ V}, f = 1\text{ MHz}$	$C_0$	12	8	10	15	32	pF
Schaltzeiten: Switching times: $I_V$ from 10 % to 90 % (typ.) $I_V$ from 90 % to 10 % (typ.) $I_F = 100\text{ mA}, t_p = 10\text{ }\mu\text{s}, R_L = 50\text{ }\Omega$	$t_r$	300	300	300	450	450	ns
	$t_f$	150	150	150	200	200	ns

Relative spektrale Emission  $\Phi_{rel} = f(\lambda)$ ,  $T_A = 25\text{ °C}$ ,  $I_F = 20\text{ mA}$

Relative spectral emission

$V(\lambda)$  = spektrale Augenempfindlichkeit

Standard eye response curve

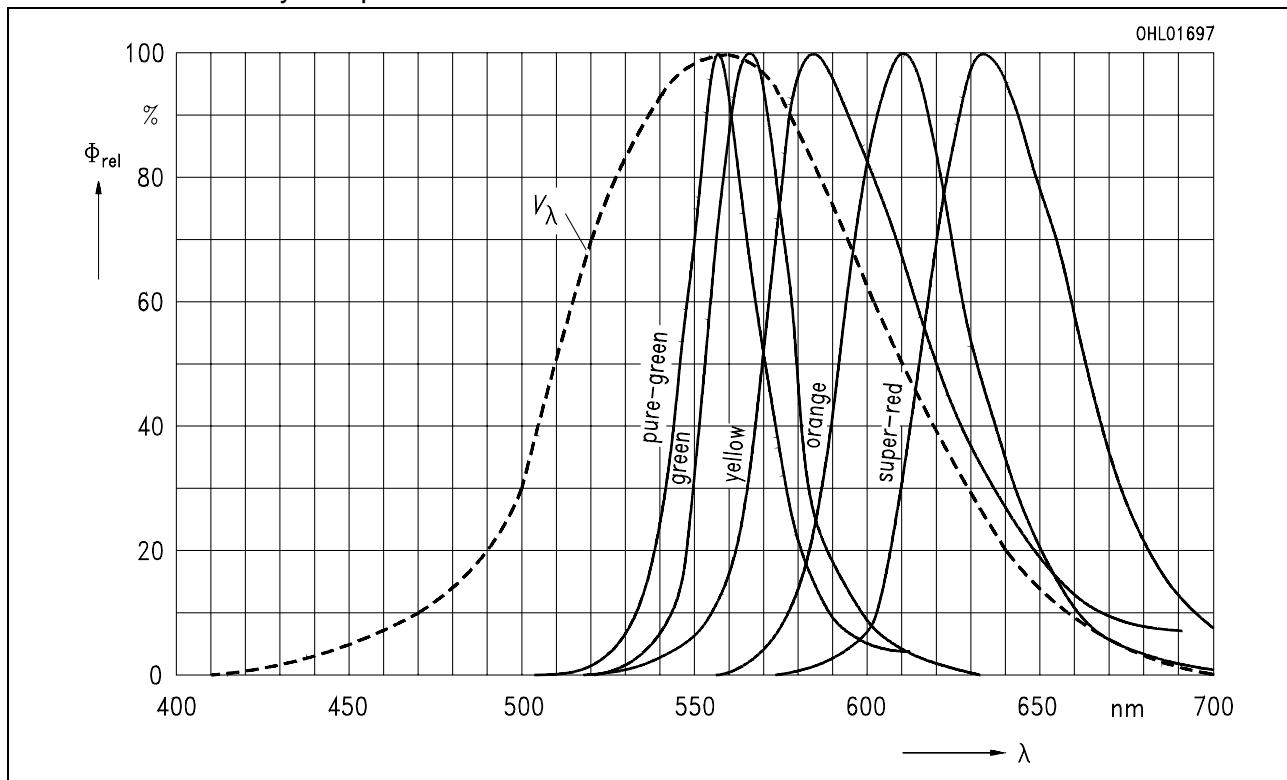

Abstrahlcharakteristik  $\Phi_{rel} = f(\varphi)$

Radiation characteristic

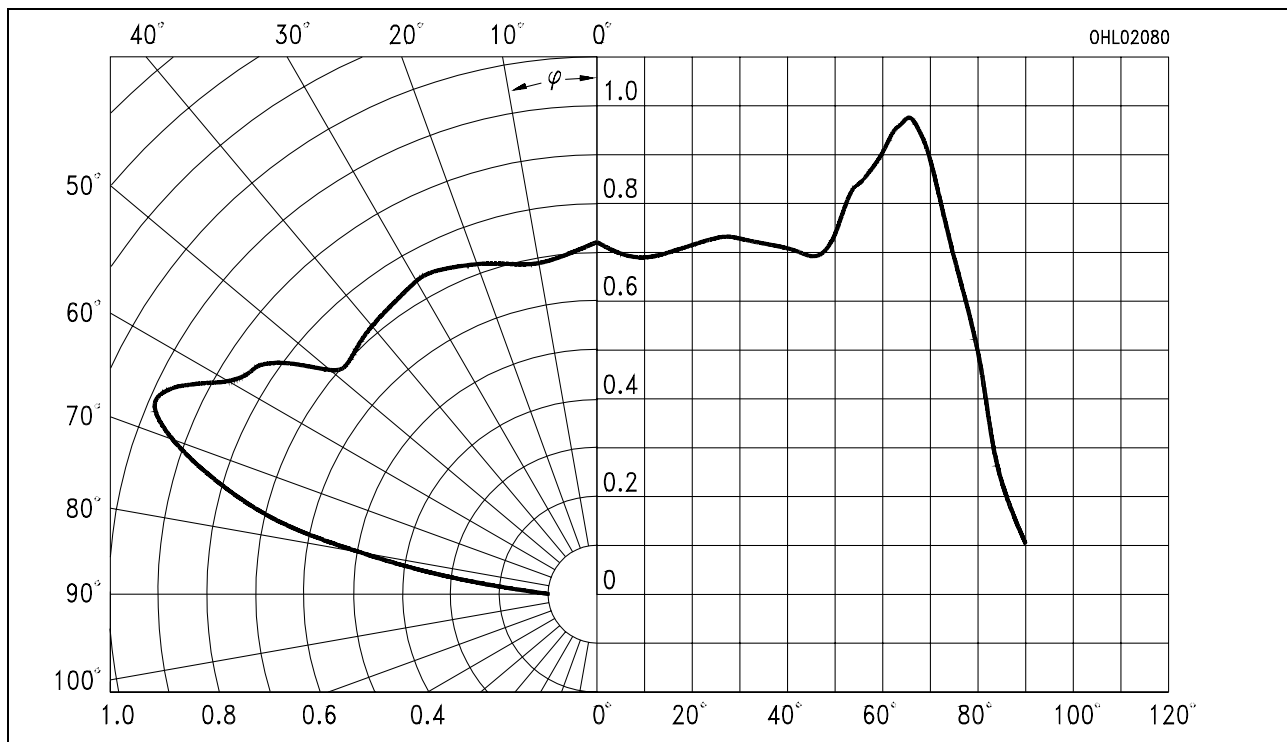

### Durchlaßstrom $I_F = f(V_F)$

#### Forward current

$T_A = 25\text{ °C}$

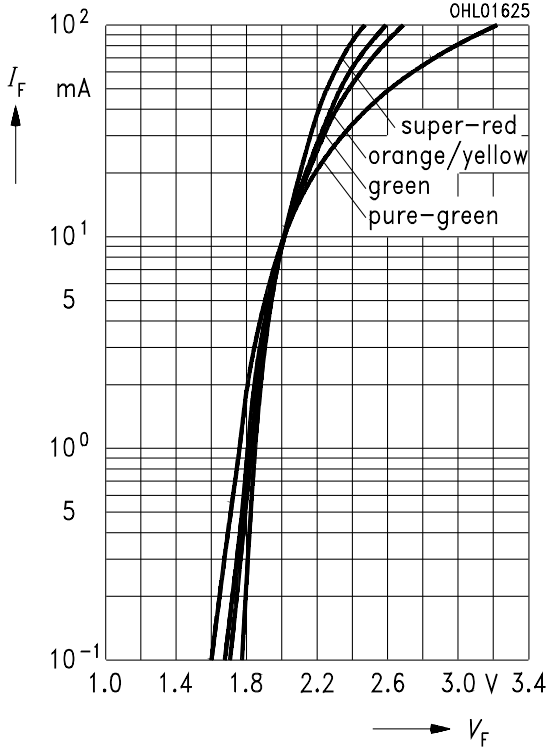

### Relativer Lichtstrom $\Phi_V / \Phi_{V(15\text{ mA})} = f(I_F)$

#### Relative luminous flux

$T_A = 25\text{ °C}$

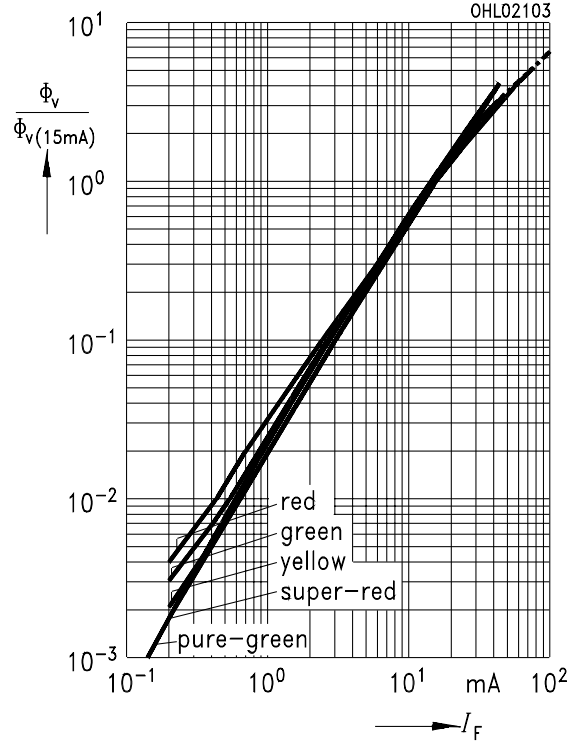

### Zulässige Impulsbelastbarkeit $I_F = f(t_p)$

#### Permissible pulse handling capability

Duty cycle  $D =$  parameter,  $T_A = 25\text{ °C}$

LS, LO, LY, LG

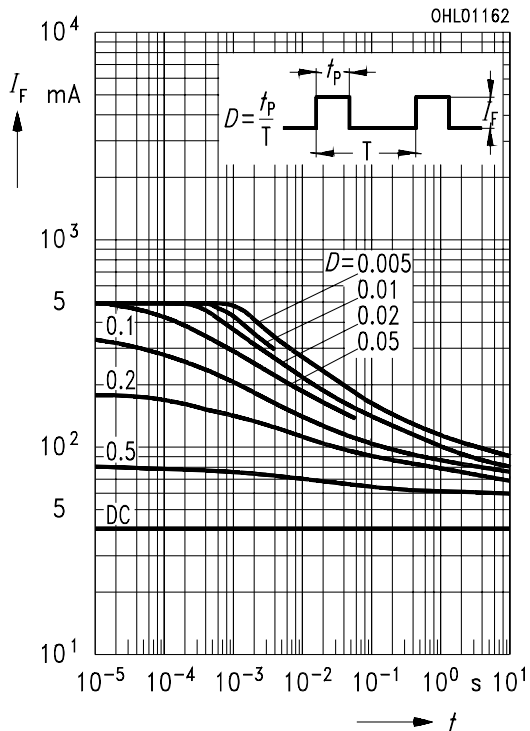

### Zulässige Impulsbelastbarkeit $I_F = f(t_p)$

#### Permissible pulse handling capability

Duty cycle  $D =$  parameter,  $T_A = 25\text{ °C}$

LP

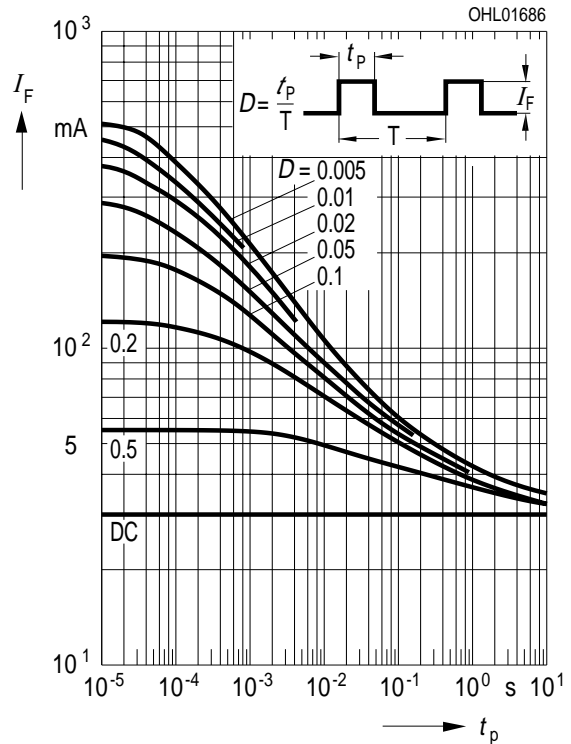

**Maximal zulässiger Durchlaßstrom  $I_F = f(T_A)$**   
**Max. permissible forward current**  
**LS, LO, LY, LG**

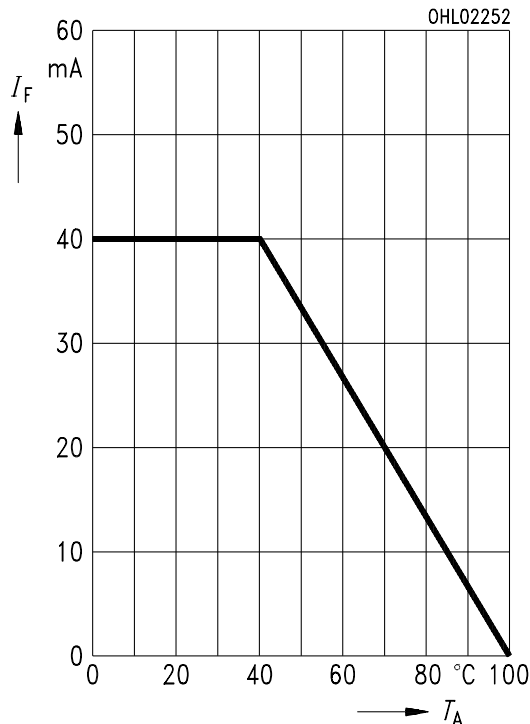

**Maximal zulässiger Durchlaßstrom  $I_F = f(T_A)$**   
**Max. permissible forward current**  
**LP**

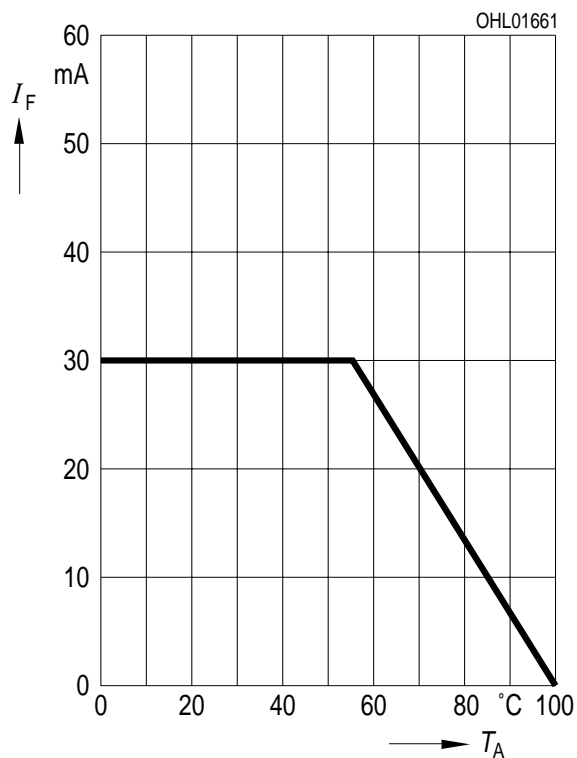

**Wellenlänge der Strahlung  $\lambda_{peak} = f(T_A)$**   
**Wavelength at peak emission**  
 $I_F = 20$  mA

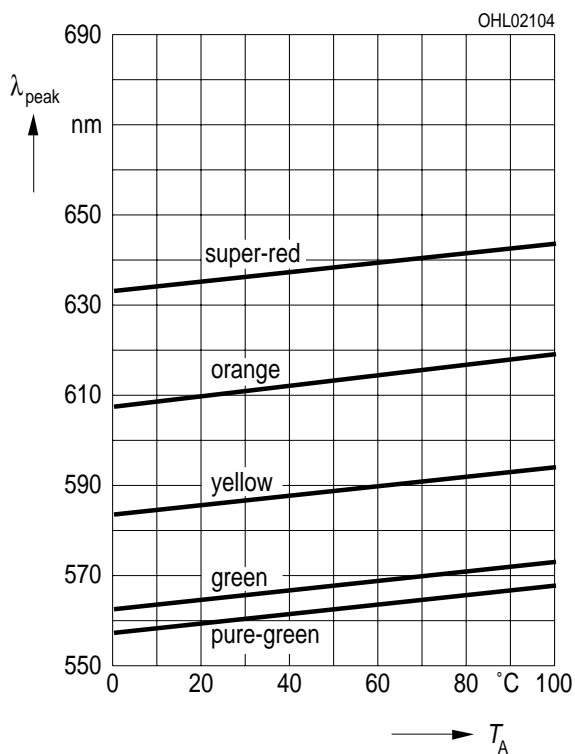

**Dominantwellenlänge  $\lambda_{dom} = f(T_A)$**   
**Dominant wavelength**  
 $I_F = 20$  mA

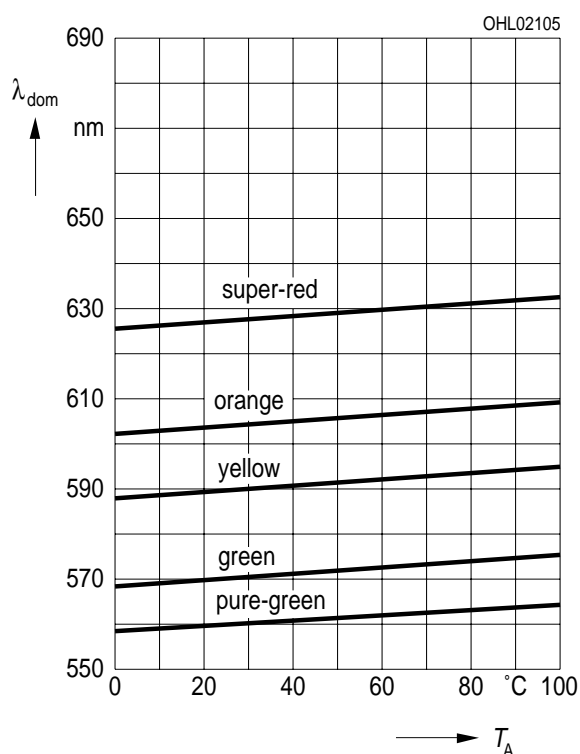

Durchlaßspannung  $V_F = f(T_A)$

Forward voltage

$I_F = 15 \text{ mA}$

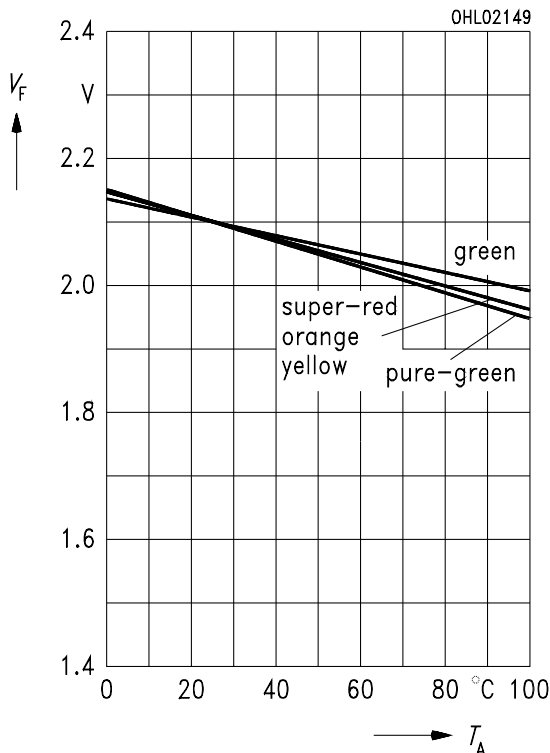

Relativer Lichtstrom  $\Phi_V / \Phi_{V(25^\circ\text{C})} = f(T_A)$

Relative luminous flux

$I_F = 15 \text{ mA}$

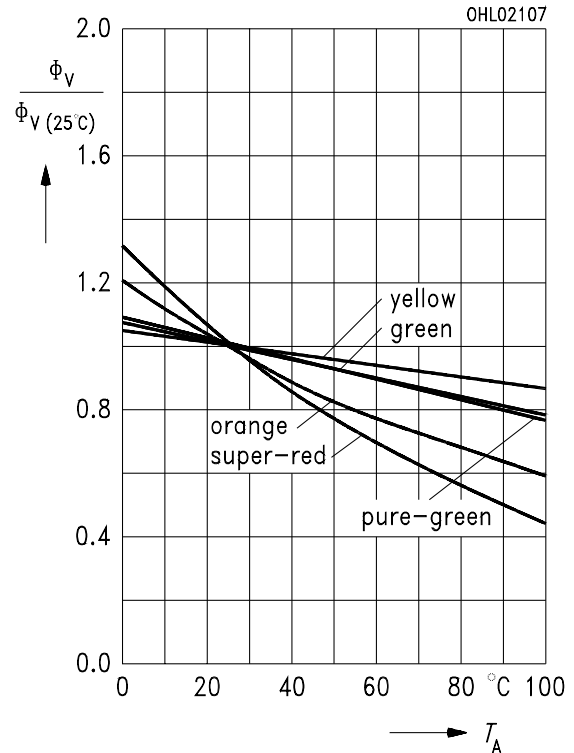

Maßzeichnung  
Package Outlines

(Maße in mm, wenn nicht anders angegeben)  
(Dimensions in mm, unless otherwise specified)

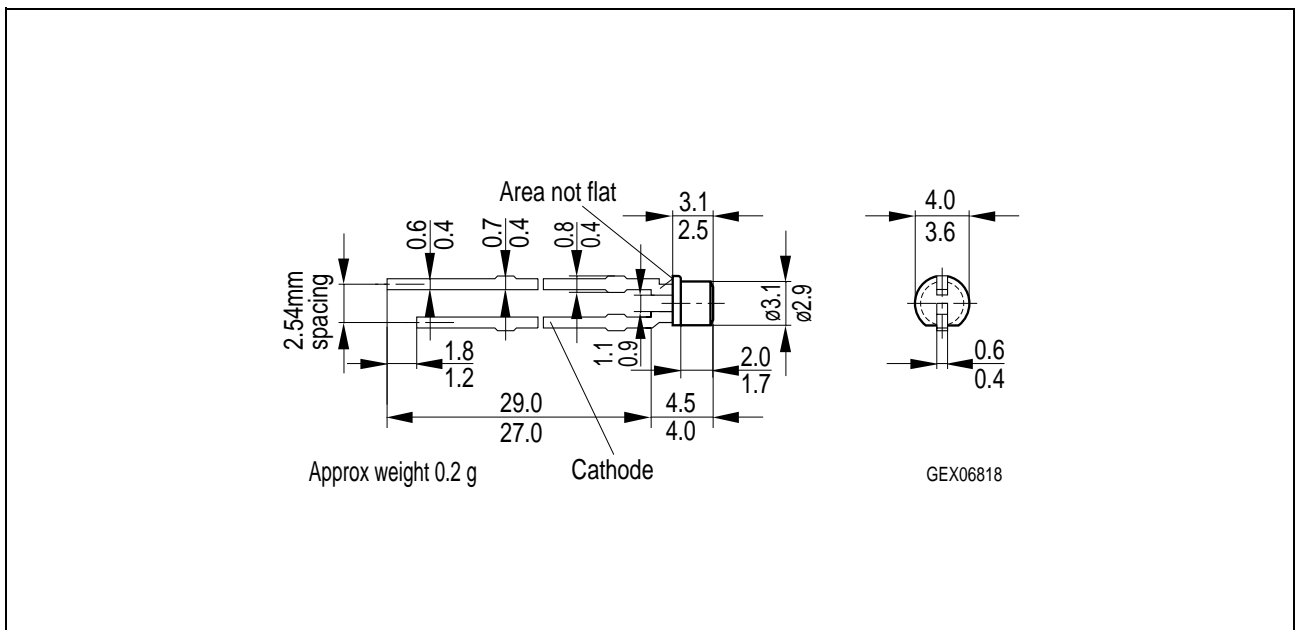

Kathodenkennzeichnung: Kürzerer Lötspieß  
Cathode mark: Short solder lead